



*Our Focus is in Plastics*

**Polymer Optics Ltd.**

6 Kiln Ride, Wokingham,  
Berks., RG40 3JL, England  
Tel/Fax: +44 (0) 1189 893341  
www.polymer-optics.co.uk

**+/-6 Degree (12 Deg) LED Collimator 7 Cell Cluster Optic - Part No. 261**

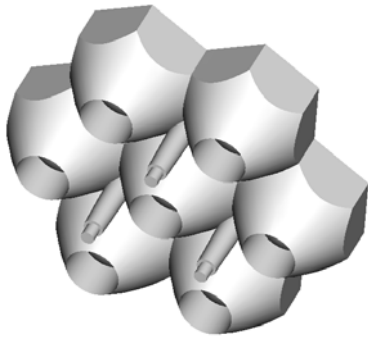

- Designed for Cree XP type LEDs – XP-E, XP-C, XP-G, etc.
- High light collection efficiency of >85%
- Precision moulded in optical grade Polycarbonate for thermal stability and system durability
- Part of the Polymer Optics “Modular LED Optics”® range

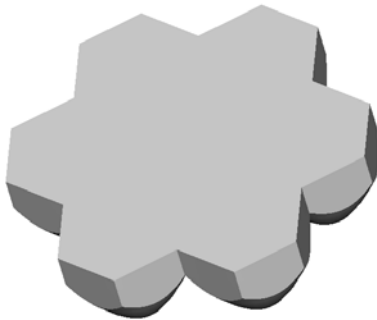

Typical dimensional tolerances  
to +/-0.2mm

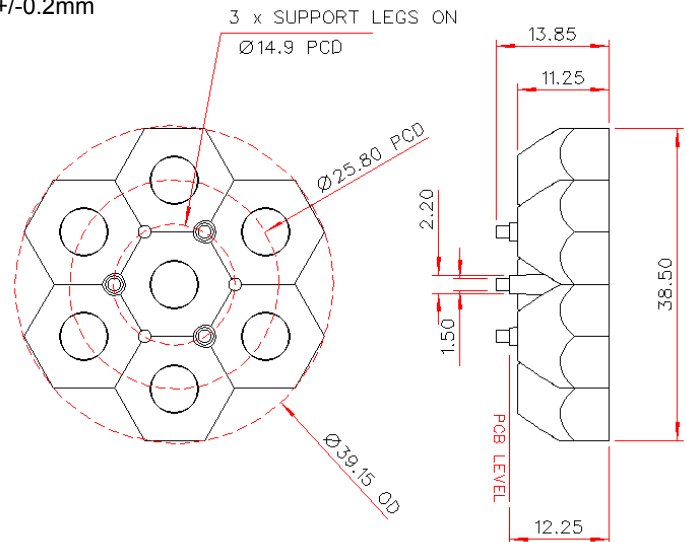

Polymer Optics “Modular LED Optics”® design, based on a hexagonal format, allows maximum packing density and assembly flexibility

Polymer Optics “Cluster Optic”® arrays can be assembled together in a number of ways to meet the needs of a range of illumination applications

The 261, 262 and 264 type “Cluster Optics”® can be mixed in the assembly to optimise the systems illumination distribution, and combined with other Polymer Optics custom cluster designs.

